

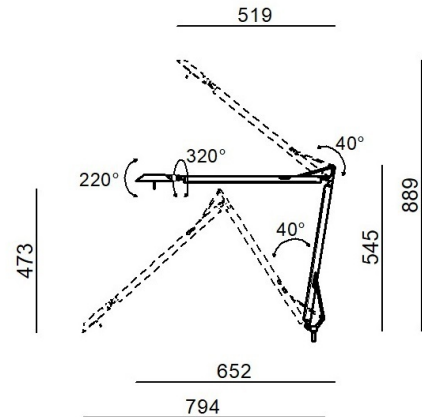

Luminaria de pared - Lámpara de mesa  
 230-240 V | 32 topLED 7 W DC - 8 W AC | CRI 90  
**CZ003IBBMDI**



Datos técnicos	
Posición de instalación	Pared - Piso
Ambiente de instalación	Interiores
Fuente de luz	LED
Circuit structure	topLED
Óptica	Difusa
Light emission direction	downward
Potencia nominal	7 W DC
Poder total	8 W
Flujo luminoso (fuente)	947 lm
Tensión nominal de entrada	220 - 240 V AC
Rango de voltaje de entrada	230 - 240 V AC
Frequency	50 - 60 Hz
CCT / Tone	2700 K
Índice de rendimientos cromático	90 Ra
C.C. / C.V.	AC
Clase de aislamiento	2
IP	IP20
Test del hilo incandescente	850°
Montaje directo sobre superficies normalmente inflamables	Sí
CE	Sí
Driver incluido.	driver
Artículo regulable	No
Orientabilidad	No
Basculación	No
Practicabilidad	No
Transitabilidad	No
Cable incluido.	Sí
Enchufe eléctrico	Type F
Largo del cable	2.7 m
Resinado	No
Tipología de emisión luminosa	Una emisión
Peso neto	0.725 Kg
Protección descargas electrostáticas	No
Protección contra sobretensiones	No

### Acabado cuerpo

Material	aluminio
Color	Text Black Ral 9005
Elaboración	Pintura

### Acabado difusor

Material	PC
Color	opalino

### Acabado base

Material	aluminio
Color	níquel
Elaboración	Galvanostegia



Luminaria de pared - Lámpara de mesa | 230-240 V | 32 topLED 7 W DC - 8 W AC | CRI 90  
**CZ003IBBMDI**

Single emission wall lights or table lamps for indoor application. The super warm white LED light source with a diffused light distribution is composed of 32 topped LEDs with CCT of 2700 K and a CRI 90; the source luminous flux is 947 lm, with a 135.3 lm/W nominal luminous efficacy.

The device body is made of aluminium and features a text black ral 9005 finish, processed by means of coating; the diffuser is made of PC. The ingress protection degree is IP20; the total weight is of 0.725 kg.

The total absorbed power is 8 W. The power supply cable is included and features a 2.7 m length.

The device features protection class II and can be wall lights or floor-mounted.

Compliant with the EN 60598-1 standard and its specific provisions.

### Características Luminotécnicas

Light Output Ratio (LOR)	78 %
Flujo luminoso (fuente)	947 lm
Flujo luminoso de luminaria	744 lm
Consumption	8 W
Rendimiento luminoso de las luminarias	93 lm/W
Temperatura de color	2700 K
Standard Deviation of Colour Matching	3 Step MacAdam
Índice de rendimientos cromático	90 Ra
Temperatura de unión (luminaria)	80
Temperatura estándar del ambiente de servicio	25°C

### LED Life / Failure Ratio

L70 B20 C0 72500h (at Tj 115 Ta 25 )

### UGR

UGR axial	27.8
UGR transversal	28.1
X=4H   Y=8H	S=0.25H
Reflection factor	70/50/20

### OPTICAL

Óptica C0/C180	114°
Light distribution simmetry	Symmetrical

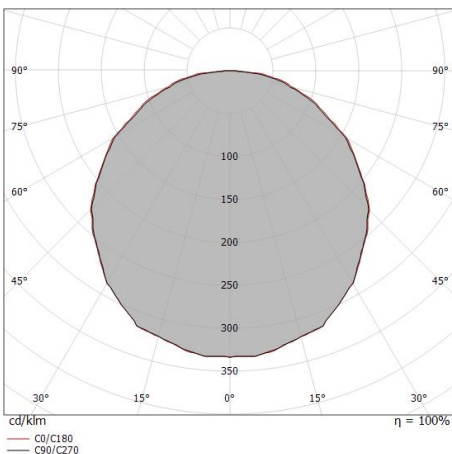

Distance [m]	Cone diameter [m]	illuminance [lx]
0.5	1.55 1.58	E(0°) 993 E(C90) 79 E(C0) 76
1.0	3.10 3.15	E(0°) 248 E(C90) 20 E(C0) 19
1.5	4.66 4.73	E(0°) 110 E(C90) 9 E(C0) 8
2.0	6.21 6.30	E(0°) 62 E(C90) 5 E(C0) 5
2.5	7.76 7.88	E(0°) 40 E(C90) 3 E(C0) 3
3.0	9.31 9.45	E(0°) 28 E(C90) 2 E(C0) 2

Distance [m] Cone diameter [m] illuminance [lx]











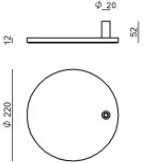

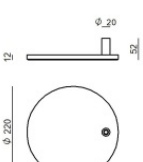

— C0/C180 (Half-peak divergence: 115.2°)  
 — C90/C270 (Half-peak divergence: 114.4°)

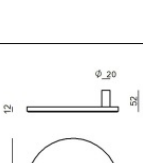

Luminaria de pared - Lampara de mesa | 230-240 V | 32 topLED 7 W DC - 8 W AC | CRI 90

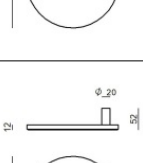
**CZ003IBBMDI**

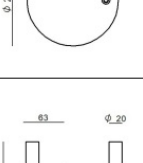
## Components

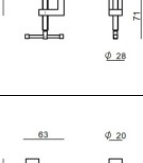
		Torino - Base	<b>Code</b> <u>CZ004RWHEZZ</u>
		Torino - Base	<b>Code</b> <u>CZ004RBBEZZ</u>
		Torino - Base	<b>Code</b> <u>CZ004RMGEZZ</u>
		Torino - Base	<b>Code</b> <u>CZ004RLUEZZ</u>
		Torino - Base	<b>Code</b> <u>CZ004RGBEZZ</u>
		Torino - Base	<b>Code</b> <u>CZ004RBEEZZ</u>
		Torino - Morsetto	<b>Code</b> <u>CZ005RBEEZZ</u>
		Torino - Morsetto	<b>Code</b> <u>CZ005RLUEZZ</u>



Luminaria de pared - Lampara de mesa | 230-240 V | 32 topLED 7 W DC - 8 W AC | CRI 90

**CZ003IBBMDI**

## Components

		Torino - Morsetto	<b>Code</b> <u>CZ005RGBEZZ</u>
		Torino - Morsetto	<b>Code</b> <u>CZ005RMGEZZ</u>
		Torino - Morsetto	<b>Code</b> <u>CZ005RBEEZZ</u>
		Torino - Morsetto	<b>Code</b> <u>CZ005RWHEZZ</u>
		Torino - Staffa Applique	<b>Code</b> <u>CZ006RBBEZZ</u>
		Torino - Staffa Applique	<b>Code</b> <u>CZ006RLUEZZ</u>
		Torino - Staffa Applique	<b>Code</b> <u>CZ006RGBEZZ</u>
		Torino - Staffa Applique	<b>Code</b> <u>CZ006RMGEZZ</u>



Luminaria de pared - Lampara de mesa | 230-240 V | 32 topLED 7 W DC - 8 W AC | CRI 90  
**CZ003IBBMDI**

## Components

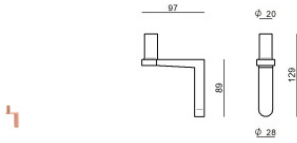

Torino - Staffa Applique

**Code**

CZ006RBEEZZ

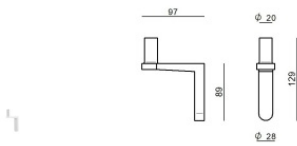

Torino - Staffa Applique

**Code**

CZ006RWHEZZ